

Development Data

Tax Parcel Number	225-044-35
Existing Zoning	R-3
Proposed Zoning	O-2 (CD)
Site Area	3.86 Ac.
Maximum Total Building Area	45,000 SF
Max. Medical Bldg. Area	25,000 SF <i>(See notes 3.2 & 3.3 to right)</i>
Parking Spaces	175 Spaces <i>(See notes 7.1 & 7.2 to right)</i>
Max. Building Height	40 Ft. (2 stories) <i>(See note 6.5 to right)</i>

Development Notes

- GENERAL PROVISIONS**
 - This rezoning petition relates to that certain 3.86 acre parcel lying within Mecklenburg County, now or formerly known as Andrew F. Young property, hereinafter referred to as the "Site".
 - Development of the Site will be controlled by the standards depicted on this Rezoning Plan and by the standards of the Ordinance. The development depicted on the Rezoning Plan is intended to reflect the arrangements of proposed buildings and uses on the Site, but the exact configurations, placements and sizes of individual elements may be altered or modified within the limits prescribed by the Ordinance during the design development and construction phases.
 - Unless more stringent standards are established by these Development Standards, all development standards established under the Charlotte Zoning Ordinance (the "Ordinance") for the O-2 District shall be followed with respect to the Site.
 - Prior to the demolition of the existing structures on the Site the Petitioner shall contact LUESA in order to evaluate potential issues related to asbestos, abandoned wells, septic tanks and underground storage, which may or may not be present on the Site.
- STATEMENTS WITH RESPECT TO THE GRAPHICS WHICH ARE SET FORTH ON EXHIBITS ACCOMPANYING THE REZONING PLAN**
 - Any Exhibits accompanying the Rezoning Plan are conceptual images of portions of the Site. They are not to be considered as development plans but rather as preliminary representations of the types and quality of development proposed for the Site.
 - The Rezoning Plan identifies building envelopes. Buildings shown on the Concept Site Plan shall be located within the building envelopes. However, the exact location, size and number of buildings within the specific envelope is subject to change.
- PERMITTED USES AND MAXIMUM DEVELOPMENT**
 - The Site may be devoted to office uses as well as associated accessory uses and parking and service areas permitted by the Ordinance in an O-2 District. However, the following uses are specifically prohibited:
 - Banks
 - Barber and Beauty Shops
 - Hotels and Motels
 - No more than 45,000 square feet of office uses may be developed on the Site.
 - Medical uses allowed by the Ordinance shall be permitted. However, in the event that the total square footage of medical uses on the Site exceeds 25,000 square feet, the maximum overall building area shall be reduced by 1.5 feet for every foot of medical use space over 25,000.
- ACCESS POINTS**
 - The total number of ingress/egress points to and from the Site shall be limited to one entrance on Ballantyne Commons Parkway and one on Williams Pond Lane. The exact locations may vary somewhat from those depicted based upon final design and location requirements as regulated by the transportation engineer and, where applicable, NCDOT.
 - The Developer shall request a median opening to allow left turn movement from westbound traffic along Ballantyne Commons Parkway into the Site. This median cut shall not allow left turn movements from the project onto westbound Ballantyne Commons Parkway. Median opening shall include a 150-foot left-turn lane and a 15:1 bay taper.
 - Williams Pond Lane is a collector street. Pavement along the property fronting Williams Pond Lane shall be widened to collector street standards. The Developer shall install 2.5 foot curb and gutter along Williams Pond Lane.
- SETBACK, SIDE YARDS AND REAR YARDS**
 - All buildings constructed on the Site shall satisfy or exceed the setback, rear yard and side yard dimensions established under the Ordinance for the O-2 District.
 - No buildings or parking areas shall be allowed in the 30 foot landscaped setbacks along Ballantyne Commons Parkway and Williams Pond Lane.
- DESIGN AND PERFORMANCE STANDARDS**
 - The proposed buildings and development will comply with all Ordinance requirements for signage, buffering, screening and landscaping.
 - The Site shall comply with all requirements of the Charlotte Tree Ordinance.
 - The Petitioner shall construct a wooden fence along the western property line abutting the existing institutional use. The fence may be located on outer portion of the western buffer pending the granting of a variance or approval of the zoning administrator according to Section 12.304 of the Ordinance. The Petitioner shall coordinate this construction with the owner of the adjoining parcel. The existing section of the chain link fence running along the eastern portion of the adjoining parcel shall be removed and the Petitioner shall "tie in" the remaining chain link fence to the new wooden fence at its sole expense.
 - The Developer shall preserve a natural buffer along the western property line. This buffer shall remain undisturbed with the exception of 10 foot "construction envelopes" to be measured from the outside edge of buildings abutting the western buffer. Vegetation within the construction envelopes may be removed. However, the Petitioner will preserve healthy hardwood trees greater than three inches in caliper which are located in the outer half of the construction envelopes. This provision shall not prohibit the Developer from removing dead or dying trees from any portion of the western buffer. Areas within the construction envelopes shall be replanted in conformity with the landscape plan for those areas. Ground surface within disturbed construction envelope areas of the buffer shall not be graded. They shall be mowed or have other natural ground cover.
 - Buildings may be located along Ballantyne Commons Parkway and Williams Pond Lane. Parking shall be located in the interior of the Site. Buildings along Williams Pond Lane and along the southwestern property line will be one story only. Buildings along Ballantyne Commons Parkway and the northeastern property may be one or two story, or a combination thereof.
 - Buildings shall be designed so that design schemes and architectural elements will be consistent on all exterior walls. Building walls facing Ballantyne Commons Parkway and Williams Pond Lane shall contain functional windows oriented toward the street.
 - All buildings shall be connected by sidewalks to sidewalks along roadways. All sidewalks shall comply with Ordinance requirements regarding width, material, and other construction specifications.
 - All sidewalks installed within the Site shall be at least five feet in width. Walks abutting parking stalls shall be seven feet in width where shown on plan (provided that a minimum three foot planting strip can be maintained between sidewalk and building face).
 - The Developer shall install a five foot sidewalk and an eight foot planting strip along Williams Pond Lane. The sidewalk may be permitted to meander within the right-of-way and setback to accommodate existing trees. Sidewalk encroachments will be granted to the City of Charlotte for portions of the sidewalk that encroach upon the subject property. This sidewalk shall be extended along Williams Pond Lane east of the site up to Ballantyne Commons Parkway.
 - All healthy trees three inches caliper and greater within the area labeled "Existing Trees to Remain" along Ballantyne Commons Parkway shall be preserved. Healthy trees greater than eight inches caliper within the setback along Williams Pond Lane shall be preserved. Amenities such as walkways, picnic sites, and benches may be located in these areas.
 - No utilities, HVAC units or other structures shall be located within the western buffer.
- PARKING**
 - Off-street vehicular parking for the Site shall meet or exceed the minimum standards established by the Ordinance.
 - The parking total indicated in the Development Data is an estimate. The final parking count may deviate from that indicated in the Development Data, provided that at the time of building permit submission the proposed parking meets or exceeds Ordinance requirements.
 - Bicycle parking shall be provided to meet or exceed the amended parking section of the Zoning Ordinance.
- LIGHTING**
 - All outdoor lighting shall be full on-off type lighting fixtures with the exception of lower, decorative lighting that may be installed along interior driveways, sidewalks, and parking areas. Site lighting will be limited to 20 feet in height and will be shielded or capped so as to minimize impact from lights that may be visible from nearby properties. No "wall wash" lighting will be installed, but architectural lighting on building facades such as accents will be permitted.
- STORMWATER**
 - The petitioner shall tie in to the existing storm water system(s). The petitioner shall have the receiving drainage system(s) analyzed, to and including the downstream culvert under Ballantyne Commons Parkway, to ensure that it will not be taken out of standard due to the development. If it is found that development will cause the a major thoroughfare, therefore the downstream culvert should adequately convey the 10-year design storm event.
 - With the exception of the building shown in drainage area 3 (see sheet RZ-2), the petitioner shall control and treat the entire runoff volume for the post-development 1-year 24-hour storm. Runoff draw down time shall be a minimum of 24 hours, but not more than 120 hours. Peak storm water release rates should match pre-development rates for the 10-year 6-hour storm event. For drainage areas 1 and 2 (shown on sheet RZ-2), the use of structural storm water treatment systems (wet ponds, extended detention wetlands, bio-retention, etc.) shall be incorporated into the site and designed to have an 85% average annual removal for Total Suspended Solids generated from the development according to specifications in the most recent version of the N.C. Department of Environment and Natural Resources Best Management Practices Manual (Design Standards shall be met according to the City of Charlotte BMP Manual, when available).
 - Not used.
 - Water quality treatment for the building in drainage area 3 (shown on sheet RZ-2), will be provided by vegetated swales.
 - The petitioner acknowledges that other standard development requirements imposed by other city ordinances, standards, policies, and appropriate design manuals will exist. Those criteria (for example those that regulate streets, sidewalks, trees, stormwater, and site development, etc.) will apply to development in addition to other standards. Where conditions on this plan differ from ordinances, standards, policies, and approaches in existence at the time of formal engineering plan review submission the stricter condition or existing requirements shall apply.

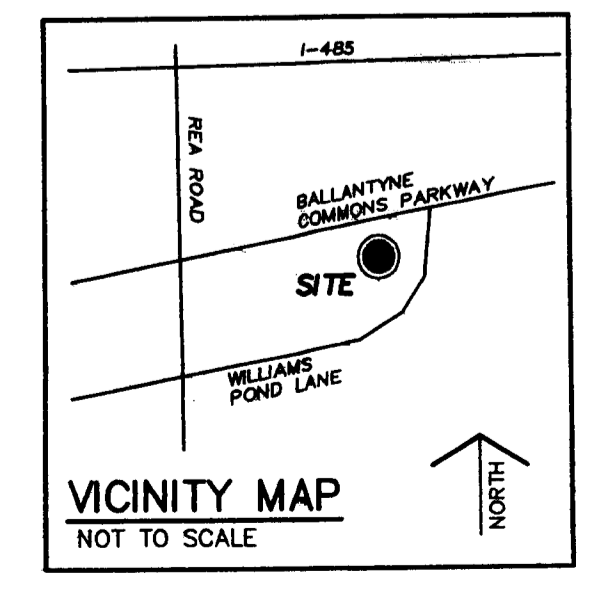
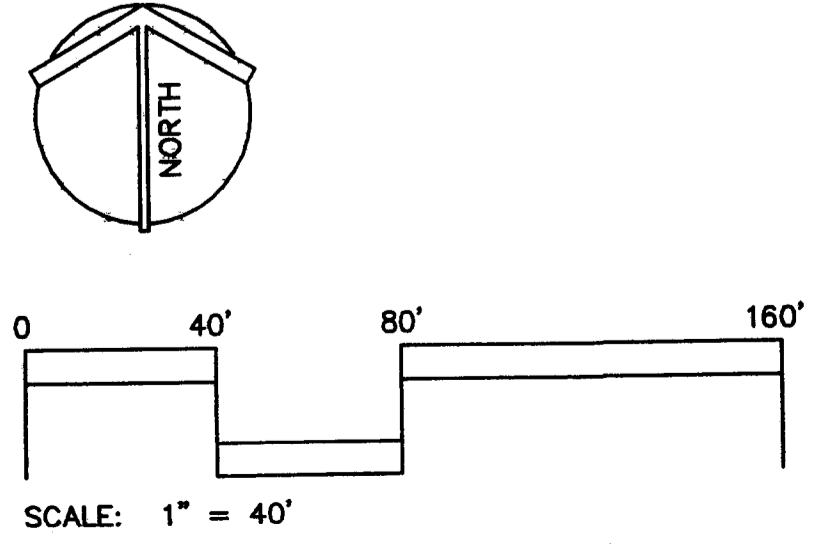
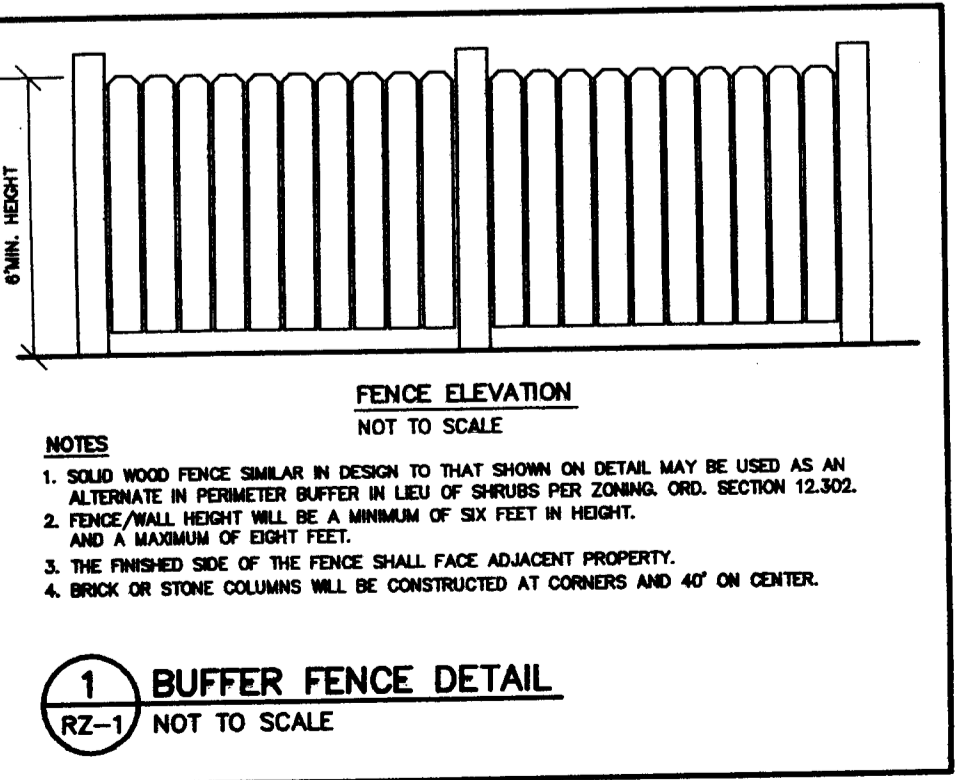
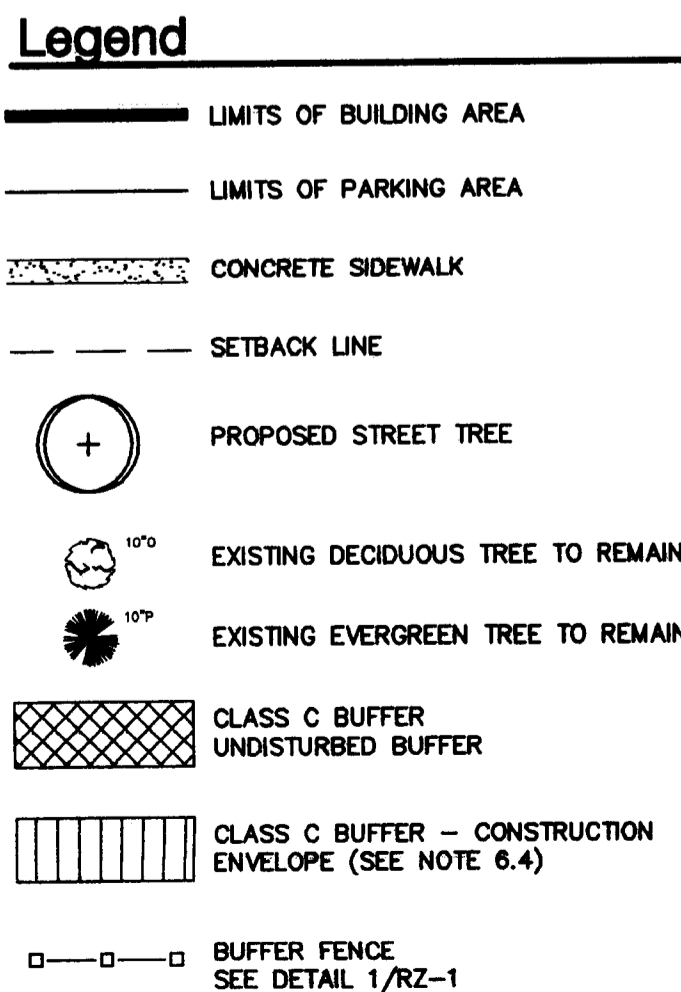
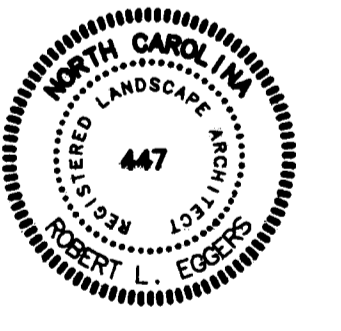
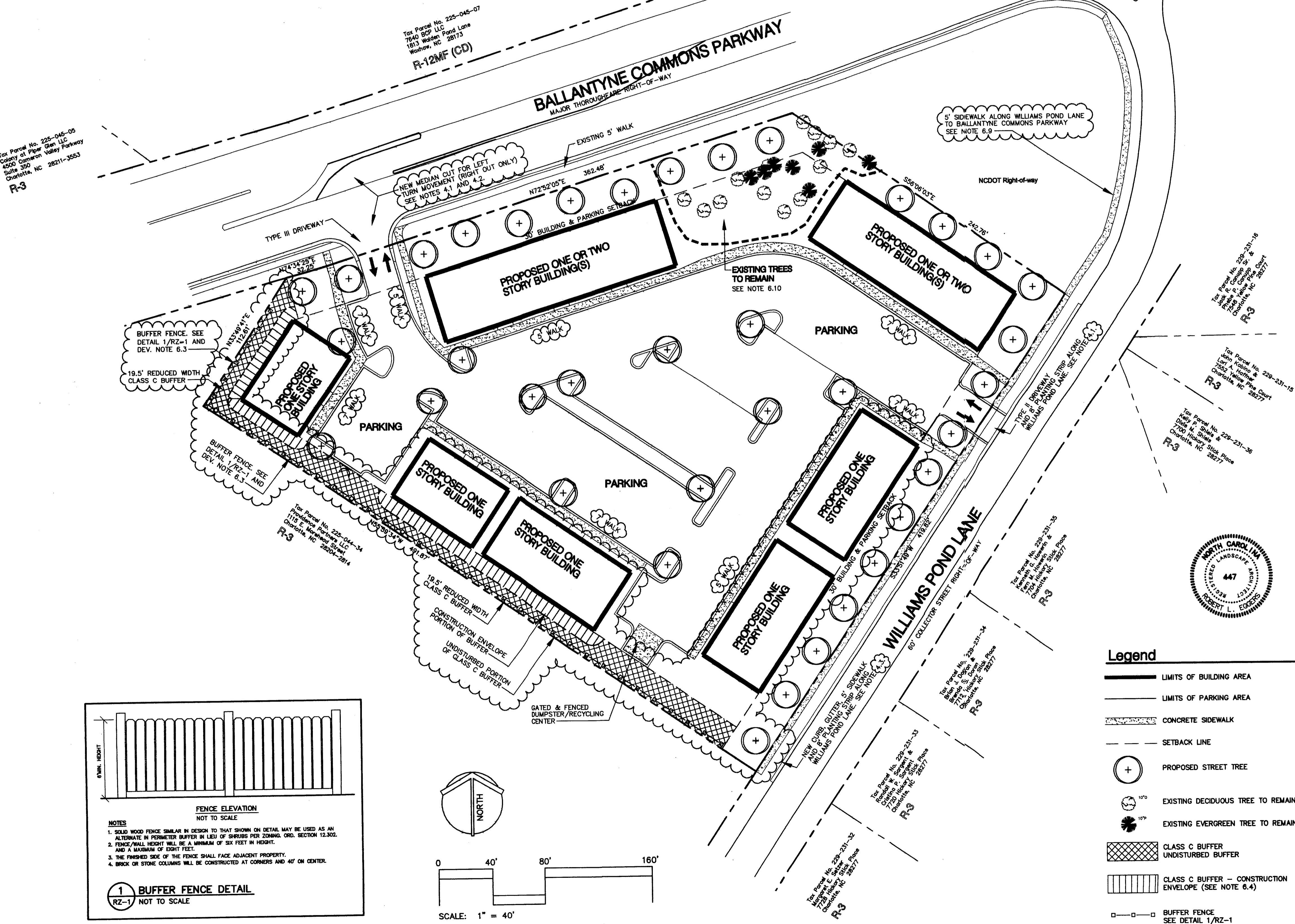

APPROVED BY CITY COUNCIL
APR 17 2006

Conditional Zoning Plan
Petition #2006-015

Ballantyne Commons Parkway Office Site
7700 Williams Pond Lane
City of Charlotte, North Carolina
For Brookchase Properties

SITE DESIGN STUDIO
6836 Executive Center Drive
Suite 116
Charlotte, NC 28212
Phone: 704-566-0708
Fax: 704-567-0880

October 21, 2005
Revisions:
11/18/05 Revised buffer & building envelopes; added detail 2; revised note 6.4; added note 6.11
2/15/06 Minor modification to parking layout; revised walk widths; revised Development Notes
3/15/06 extended buffer fence along northeast property line
3/15/06 Revised Development Notes 9.2, 9.3, and 9.4
4/12/06 Revised Development Note 8.1

COMM. NO. 0505

RZ-1
DIST. 1 OF 2

AREA NO.	BASIN AREA	BMP AREA	BASIN %
1	1.48	0.074	5.0%
2	1.41	0.078	5.5%
3	0.97	0.054	5.1%
TOTAL AREA	3.86	0.206	5.3%

Notes

- Stormwater management practices shown on this plan are schematic in nature and subject to revision pending final site engineering at the time of plan submittal with the City of Charlotte Engineering Department.
- Stormwater management practices shown on this plan designed by Lash Engineering, Inc., which will be the anticipated engineering firm submitting final designed stormwater management plan to the City of Charlotte Engineering Department.
- See Development Notes, Section 9, on sheet RZ-1 for additional Stormwater Management Practices required with this petition.

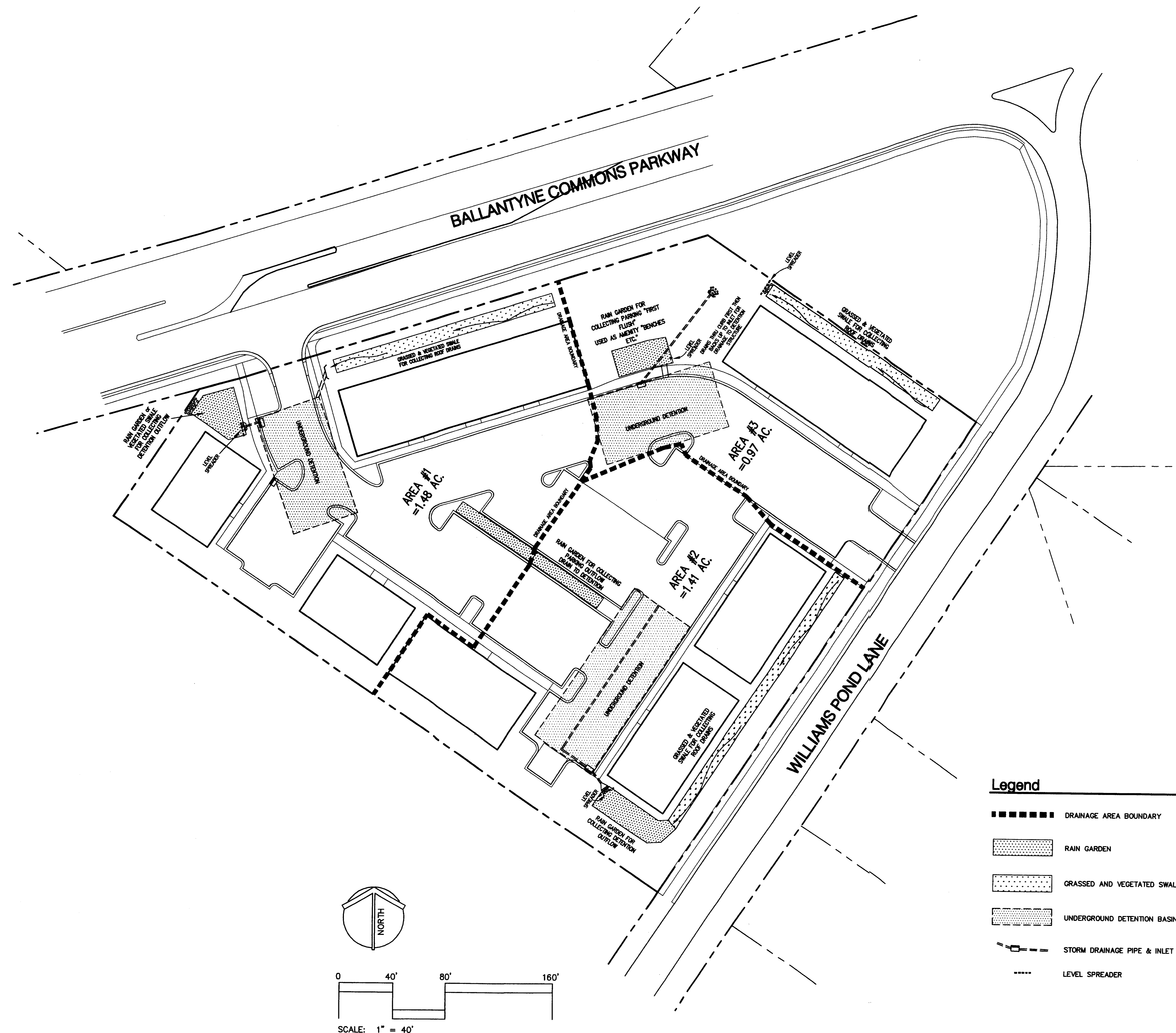

Legend

- DRAINAGE AREA BOUNDARY
- [Stippled Box] RAIN GARDEN
- [Dotted Box] GRASSED AND VEGETATED SWALE
- [Cross-hatched Box] UNDERGROUND DETENTION BASIN
- S--- S--- STORM DRAINAGE PIPE & INLET
- LEVEL SPREADER

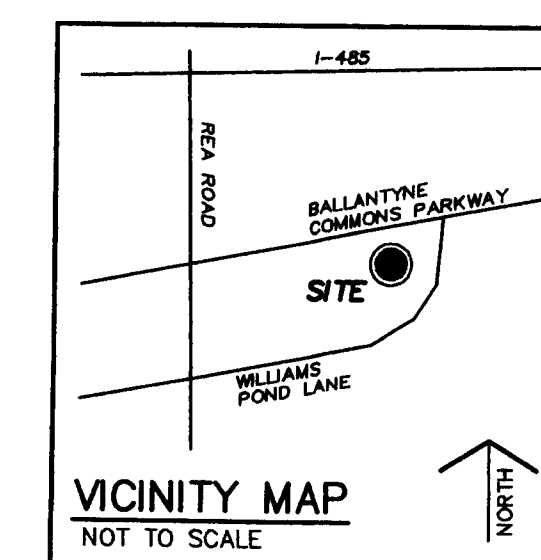

**Schematic Storm Water Management Plan
Petition #2006-015**

Ballantyne Commons Parkway Office Site
7700 Williams Pond Lane
City of Charlotte, North Carolina
For Brookchase Properties

SITE DESIGN STUDIO
LAND PLANNING & LANDSCAPE ARCHITECTURE
5835 Executive Center Drive
Suite 115
Charlotte, NC 28212
Phone: 704-596-0706
Fax: 704-567-0980

RZ-2
Sheet 2 of 2